

# Effect of Land Surface Processes on Precipitation Isotopes

\*Kei YOSHIMURA

\* Institute of Industrial Science, the University of Tokyo,  
4-6-1 Komaba, Meguro-ku, Tokyo 153-8505, Japan

e-mail: kei@iis.u-tokyo.ac.jp

## Abstract

Precipitation isotopes variability is dominantly controlled by large-scale atmospheric moisture transport processes. However, we cannot neglect some possible effect of land surface processes on the variability of precipitation isotopes; in particular, the effect on diurnal variations on precipitation seems quite large. To take a deeper insight on short-term variability of precipitation isotopes, including diurnal variability, the authors developed an isotope-incorporated land surface model (LSM) coupled with the existed atmospheric isotope circulation model. The original land surface model was MATSIRO (Minimal Advanced Treatments of Surface Interaction and Runoff) and the atmospheric model was the Rayleigh-type isotope circulation model (ICM).

*Keyword: Precipitation Isotopes, Kinetic Fractionation, LSM, GAME reanalysis*

## 1. Introduction

Stable isotopes of water (HDO and H<sub>2</sub><sup>18</sup>O) are good tracers of hydrologic cycle, because their concentrations in water portion indicate integrated records of physical phase-changes. In particular, large heterogeneity of precipitation isotopes in time and space is regarded as proxies of complex atmospheric behavior. In the past, many observational studies on precipitation isotopes have been carried out, and lately the simple two-dimensional isotope circulation model by Yoshimura et al. (2003) showed that the heterogeneity of observed precipitation isotopes is dominantly controlled by large-scale atmospheric moisture transport processes. Their model reproduced daily H<sub>2</sub><sup>18</sup>O variability over the sub-tropics, particularly Thailand, and monthly averages at global scales with GNIP (Global Network of Isotopes in Precipitation: WMO/IAEA). However, there remain discrepancies between the observation and the simulations. Effect of land surface processes, which was neglected in the model, is one of the causes. This paper, to take a deeper insight on short-term variability of precipitation isotopes, incorporates behavior of the isotopes into land surface model and analyzes isotopic land-atmosphere interaction and effect of land on the atmosphere by coupling it with the atmospheric isotope circulation model.

## 2. Design of Models

### 2.1. Isotope Land Surface Model

The study used MATSIRO (Minimal Advanced Treatments of Surface Interaction and Runoff) in Takata et al. (2003) as the original LSM. The main reasons are; MATSIRO is designed to be coupled with atmospheric general circulation models (AGCMs) and optimized for large scale global simulations; it has three distinct treatments of evapotranspiration that possibly make differences in isotopic fractionation, such as evaporation from soil, transpiration from vegetation, and evaporation from intercepted water by canopy; and vertical soil water transport and advective water runoff are explicitly considered based on physical equations.

In Iso-MATSIRO, all variables that contains water amount or flux have respective isotopic concentrations.

In every timestep, these isotopic concentrations are computed with satisfaction of isotopic mass balances. When phase-changes (*e.g.*, liquid to gas) take place, isotopic fractionation are taken into account. Particularly in case of release from the system (*e.g.*, evapotranspiration), kinetic fractionation are conducted as follows (transpiration is shown):

$$Et = \rho C_{Et} |V_c| (q_{s(T_c)} - q_a) \quad (1)$$

$$Et^* = \rho C_{Et}^* |V_c| (q_{s(T_c)} R_{leaf} \alpha_{(T_c)} - q_a R_a) \quad (2)$$

$$R_{Et} = \frac{Et^*}{Et} = \frac{C_{Et}^*}{C_{Et}} \left[ \frac{q_{s(T_c)} \alpha_{(T_c)} R_{leaf} - q_a R_a}{q_{s(T_c)} - q_a} \right] \quad (3)$$

where  $\rho$  is concentration of water;  $C_{Et}$  and  $C_{Et}^*$  denote bulk coefficients of water and isotopes against water vapor, respectively, where the roughness that considers surface resistances is taken into account; the ratio of the bulk coefficients,  $C_{Et}^*/C_{Et}$  is known as the kinetic fractionation coefficient, and this study regards it as a function of wind speed (Merlivat and Jouzel, 1979);  $q_s$  and  $q_a$  indicate saturated specific humidity and that of air vapor, respectively;  $R_{leaf}$  and  $R_a$  denote isotopic composition of water in leaves and air vapor, respectively;  $T_c$  is temperature at a canopy height; and  $\alpha$  is equilibrium fractionation factor obtained from Majoube (1979).

Any type of phase-changes (*e.g.*, evaporation or sublimation) is similarly described as above formulae, by substituting respective isotopic composition (*e.g.*, soil water, snow, etc.). Note that this study used the same the kinetic fractionation factor regardless of type of evaporation, but it may be affected by turbulence intensity (Riley et al., 2002).

For running the model, surface boundary conditions are required; specific humidity, wind speed, temperature, pressure, downward radiation, precipitation (convective and large scale), and isotopic compositions of precipitation (convective and large scale) and vapor. Land use types and soil types, and their physical parameters, are taken from the default setting of the global soil wetness project 2 (Dirmeyer et al., 2002). The model resolution is, horizontally  $1^\circ \times 1^\circ$ , and vertically five soil layers (5, 20, 25, 25, and 100 cm).

## 2.2. Coupling with Atmospheric Isotope Model

For atmospheric circulation computation, this study uses the Rayleigh-type isotope circulation model (ICM) in Yoshimura et al. (2003, hereafter Y03). ICM is forced by external meteorological conditions including precipitation, evaporation, precipitable water vapor, and vapor fluxes, and it calculates isotopic fractionation by employing Rayleigh equation between precipitable water vapor and precipitation. Resolution is, horizontally  $1^\circ \times 1^\circ$ , and vertically one layer.

Coupling structure of ICM and Iso-MATSIRO is shown in Fig.1. Isotopes in evaporative flux over land surface are given from Iso-MATSIRO to ICM, and isotopes in precipitation flux and ambient vapor are given from ICM to Iso-MATSIRO. Over oceans,  $\delta^{18}\text{O}$  in evaporative flux are assumed to have a fixed value,  $-5\text{‰}$ , whereas it was  $-9.4\text{‰}$  in Y03. Other boundary conditions are taken from GAME reanalysis (Yamazaki et al, 2000) every 6 hours. Global simulation is carried out for 1 April to 31 October in 1998, after twice April as spin-up. Both the model timestep and coupling frequency are 10 minutes.

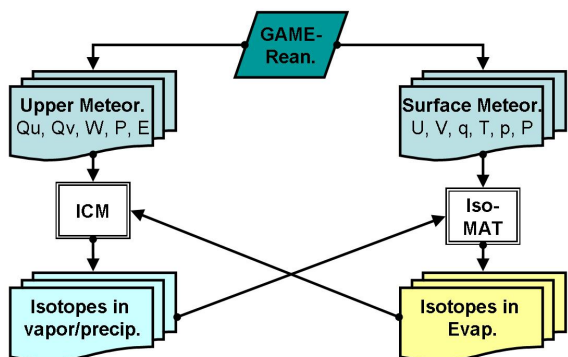

Fig. 1: Schematic representation of coupling of Iso-MATSIRO and ICM.

## 3. Results and Validations

### 3.1. At Specific Site

Figure 2-6 show simulated results at Chiangmai (18.8N, 99.0E), Thailand, for 1 April to 31 October in 1998. In this simulation, land type of a grid including Chiangmai was categorized as mixture of coniferous and broadleaf deciduous forest and woodland, and soil type was clay loam. Fig.2 shows states of water storages in each of five soil layers, Fig.3 presents precipitation and runoff amount, Fig.4 is isotopic compositions of soil water storages, precipitation, and runoff, Fig.5 displays isotopic compositions of evaporation from bare soil, transpiration from vegetation, and evaporation from canopy-interception, and Fig.6 shows comparison of precipitation isotopes between observation, the control simulation in Y03, and the land-atmosphere coupled simulation.

The results indicate isotopes in surface soil layer are largely influenced by precipitation isotopes, but it is hardly affected below 25cm. Moreover, isotopic values in evapotranspiration flux widely fluctuate with a little relation with that in precipitation. Weighted

averages for the simulation period (7 months) of land-atmosphere water fluxes are shown in Table 1. It should be noted that the common assumption in many isotopic models, evapotranspired isotopes are equal to precipitation isotopes, should be reconsidered. Finally, the comparison with the observations shows the precipitation isotopes are better reproduced in the coupled simulation than simulations with simple evaporation isotopes in Y03. The correlation coefficient increases a little, 0.74 to 0.75, but bias and RMSE (root mean square error) significantly decrease (improve),  $-3.2\text{‰}$  to  $0.7\text{‰}$  and  $4.2\text{‰}$  to  $2.7\text{‰}$ .

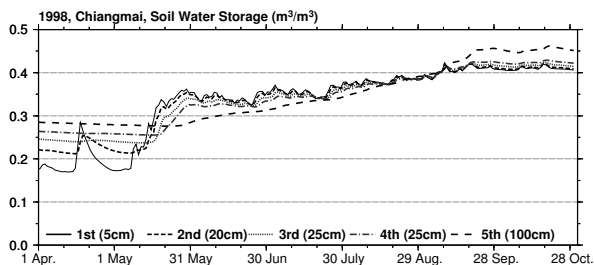

Fig. 2: Temporal variations in soil water storages of five layers, at a grid including Chiangmai, Thailand.

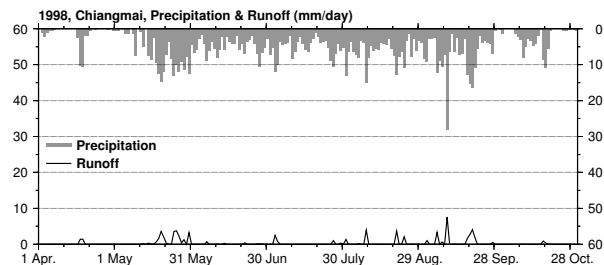

Fig. 3: As Fig.2, but for Precipitation and (total) runoff amount.

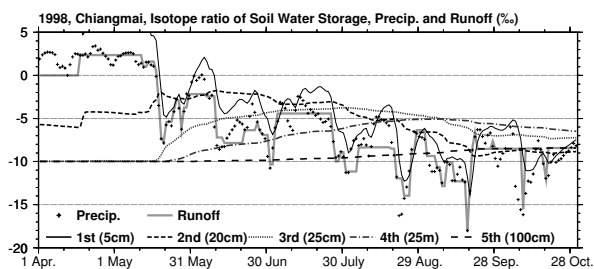

Fig. 4: As Fig.2, but for Isotopic compositions ( $\delta^{18}\text{O}$ ) of soil water in each layer, precipitation, and runoff.

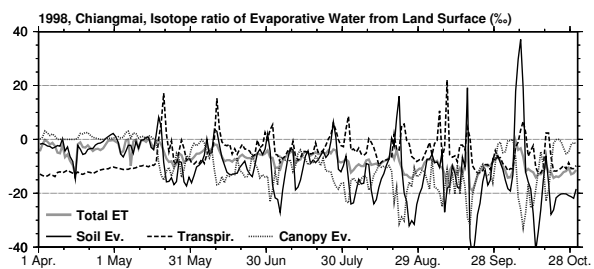
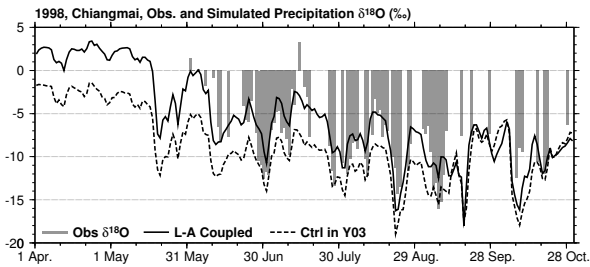

Fig. 5: As Fig.2, but for Isotopic compositions ( $\delta^{18}\text{O}$ ) of evaporation from bare soil, transpiration, evaporation from intercepted water, and total evapotranspiration.



**Fig. 6:** Comparison of simulated  $\delta^{18}\text{O}$  in precipitation with observations (bar) and control simulation in Y03 (dashed line), at Chiangmai, Thailand.

**Table 1:** Weighted averages of isotopic compositions in fluxes for Apr.1 to Oct.31, 1998, at Chiangmai, Thailand.

	flux (mm/day)	$\delta^{18}\text{O}$ (‰)
Soil evap.	0.78	-9.65
Transp.	0.69	-5.35
Canopy evap.	1.30	-7.21
Total ET	2.77	-7.43
Precip.	4.67	-7.00

### 3.2. Global Perspective

Figure 7-11 show global  $\delta^{18}\text{O}$  distributions in principal surface water variables, precipitation (Fig.7), evapotranspiration (Fig.8), runoff (Fig.9), soil storage in the surface layer (Fig.10), and canopy intercepted water (Fig.11), for 7 months. In Fig.7, we can find large scale “continental effect” north-eastward in Eurasian continent, northward in the north America, and westward in the south America. They reflect more or less similar isotopic distributions in other variables. However, because of influences of complex land surface processes, intensity of direct impact of precipitation varies. For example, canopy water (Fig.11) and surface soil storage (Fig.10) are relatively more influenced by precipitation, but evaporation (Fig.8) and runoff (Fig.9) are less.

These results indicate that previous treatments of isotopes in land surface, such as “no fractionation and direct return of precipitation isotopes (Jouzel et al., 1987; Hoffmann et al., 1998; Mathieu et al., 2002)” or “uniform isotopic value in evaporation (Yoshimura et al., 2003)”, are quite rough estimates. Fig.12 displays the impact of this “physically reasonable, but computationally expensive” treatment on precipitation isotopes. The coupled model simulation monthly results are compared with control simulation in Y03 and the GNIP observations. Similarly as the point validation in Fig.6, there is no change in correlation, but the systematic bias decreases, from  $-3.4$  ‰ to  $0.9$  ‰. RMSE decreases, too, from  $4.6$  ‰ to  $3.3$  ‰. Therefore, the land surface treatments for isotope circulation are necessary for not only for runoff and river water isotope estimations, but also for more reasonable precipitation isotope estimation.

### 4. Summary and Conclusion

In this study, physical behavior of stable water isotopes is incorporated to one of LSMs, MATSIRO, which is designed and optimized to be coupled with global atmospheric model. In this Iso-MATSIRO, three distinct treatments of evapotranspiration that possibly make

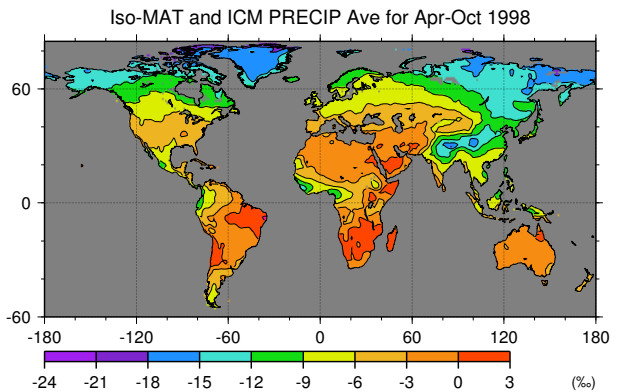

**Fig. 7:** Global distribution of  $\delta^{18}\text{O}$  in precipitation as weighted average for Apr. to Oct., 1998.

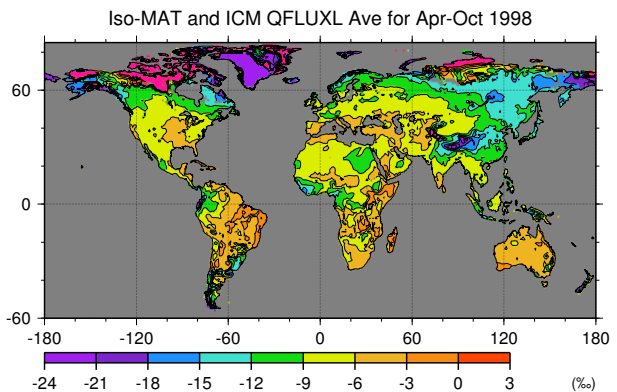

**Fig. 8:** As Fig.7, but for total evapotranspiration.

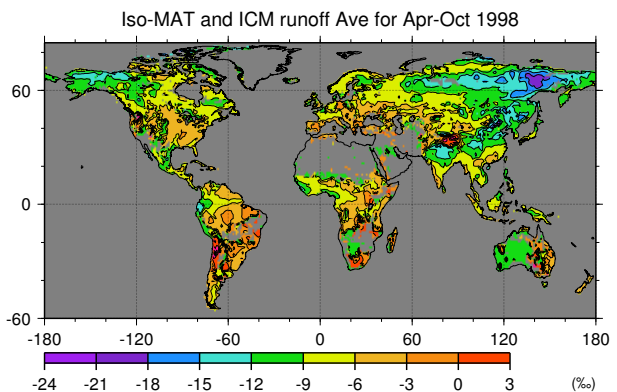

**Fig. 9:** As Fig.7, but for total runoff.

differences in isotopic fractionation are taken into account, such as evaporation from soil, transpiration from vegetation, and evaporation from intercepted water by canopy. In case phase-changes (*e.g.*, liquid to gas) take place, kinetic isotopic fractionation, in addition to equilibrium fractionation, are explicitly conducted.

The results show there are very large fluctuations of isotopic compositions in evaporative fluxes and very near surface water, such as canopy water and the first layer (5cm) of soil. By taking those into account, the daily variations of observed precipitation  $\delta^{18}\text{O}$  was slightly better reproduced in Chiangmai, Thailand, than the atmospheric isotope circulation simulation without land surface processes in Yoshimura et al. (2003). Moreover, global comparison with GNIP

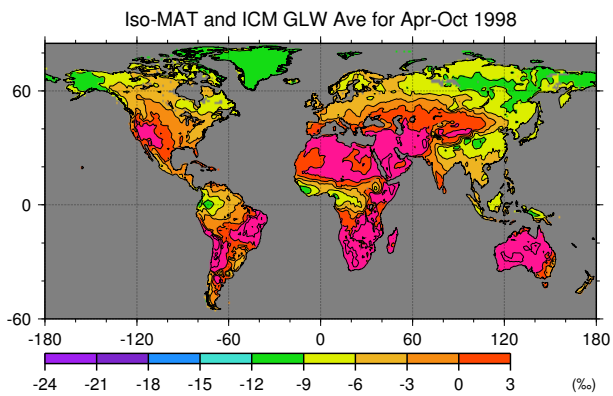

**Fig. 10:** As Fig.7, but for soil water storage of the first soil layer.

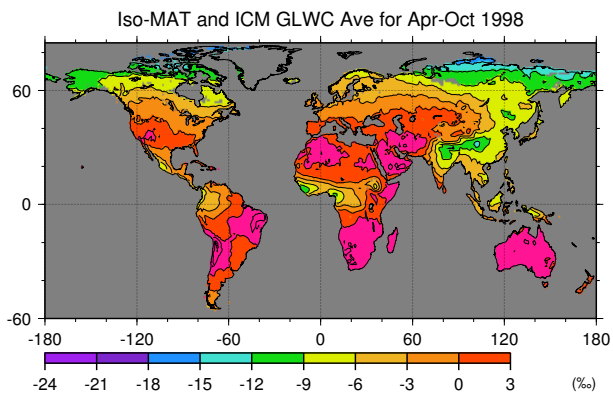

**Fig. 11:** As Fig.7, but for canopy intercepted water.

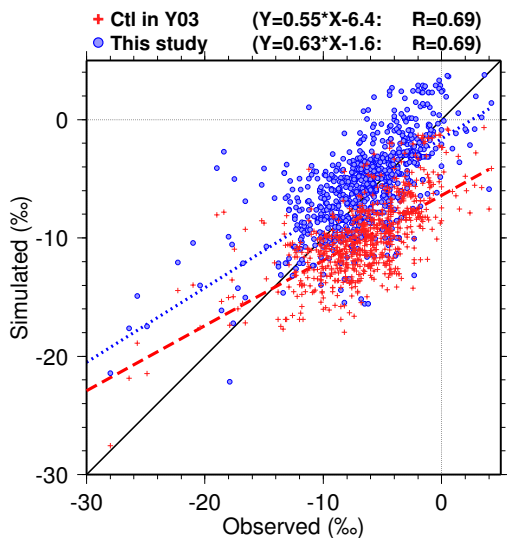

**Fig. 12:** Simulated monthly precipitation  $\delta^{18}\text{O}$  are compared with GNIP observations for Apr. to Oct.,1998. Land-atmosphere coupled simulation results are shown as blue circles, and control simulation results in Y03 (without land surface processes) are shown as red crosses.

observations show better agreement in this study, too.

This study did not tune any physical parameters related with water and energy equations, and did not examine variables except isotopes, such as water and energy variables. These processes are significantly important and more direct way for improvement of the LSM, but what the current study tries is another way

of diagnose of the LSM. Even though reasonable energy and water budgets are somehow computed in LSMs, these results may be systematically wrong answer, thus isotopes can additionally tell that it is “truly” reasonable or not.

Nevertheless, this study indicated land surface processes should be reasonably taken into account for more precise estimation of precipitation isotope distribution. In these regards, reproduction of d-excess parameter ( $\delta\text{D} - 8 \times \delta^{18}\text{O}$ ) in precipitation would be the next step.

**Acknowledgments.** Parts of this study were supported by Core Research for Evolutional Science and Technology (CREST), the Japan Science and Technology Corporation (JST), Special Coordination Funds for Promoting Science and Technology, and Research Institute for Humanity and Nature (RIHN).

## References

- Dirmeyer et al., *IGPO Publication*, **37**, 2002.
- Hoffmann et al., *JGR*, **103**, 16,871-16,896, 1998.
- Jouzel et al., *JGR*, **92**, 14,739-14,760, 1987.
- Majoube, *JPC*, **197**, 1423-1436, 1979.
- Mathieu et al., *JGR*, **107**, doi:10.1029/2001JD-900255, 2002.
- Merlivat and Jouzel, *JGR*, **84**, 5029-5033, 1979.
- Riley et al., *GBC*, **16**, doi:10.1029/2002GB001878, 2002.
- Takata et al., *GPC*, **38**, 209-222, 2003.
- Yamazaki et al., *Tenki*, **47**, 659-663, 2000 (in Japanese).
- Yoshimura et al., *JGR*, **108**, doi:10.1029/2003JD-003477, 2003.